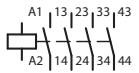
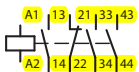
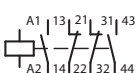

- > Six and eight-pole relays available by adding snap-on auxiliary contact block
- > Positively guided contacts; NO and NC contacts can never be closed simultaneously
- > Share common accessories with Moeller's popular DIL M contactor line

DILA Control Relays with AC Coil, 4-pole ①

Control Relay	Schematic	Contacts		UL/CSA		Catalog Number	Price
		NO	NC	Pilot Duty Rating	General Purpose (A)		
		4	0	A 600 P 300	10	DILA-40◆	124
		3	1			DILA-31◆	124
		2	2			DILA-22◆	124

AC Coil Codes ①

Complete catalog number (◆) with...	Voltage Range	
	50Hz	60Hz
(24V60HZ)	–	24V
(42V50HZ,48V60HZ)	42V	48V
(110V50HZ,120V60HZ)	110V	120V
(208V60HZ)	–	208V
(230V50HZ,240V60HZ)	230V	240V
(415V50HZ,480V60HZ)	415V	480V
(600V60HZ)	–	600V

UL/CSA Rating Codes (per UL508 and CSA 22.2 No. 14-95)

UL/CSA Standard	Continuous Amps	Circuit Voltage								VA	
		120VAC		240VAC		480VAC		600VAC		Make	Break
A600	10	60	6	30	3	15	1.5	12	1.2	7200	720
UL/CSA Standard	Continuous Amps	Make	Break	Make	Break	Make	Break			VA	
P300	5	1.1	1.1	0.55	0.55	–	–			138	138

NOTE: This table represents minimum requirements to achieve a rating of A600/P300. All Moeller relays meet or exceed these standards.

① Other coil voltages between 12 and 600VAC available by special order; Contact your Moeller representative for information.

Ordering Instructions

- 1 Locate the desired control relay.
- 2 Complete catalog number with coil code.
- 3 See pages F10 – F13 for auxiliaries and accessories.

Dimensions are in millimeters.
Not intended for manufacturing purposes.

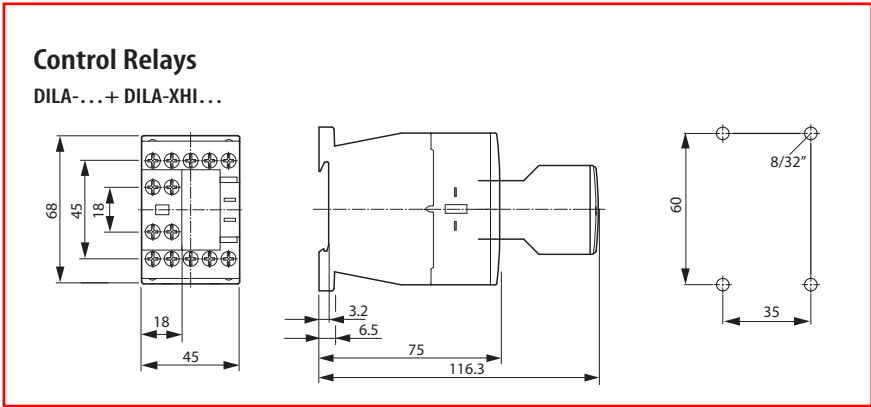

Control Relays

DILER-...

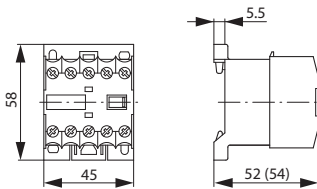

Control Relays

DILER-... + HDILE

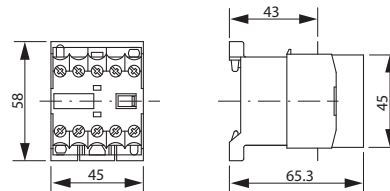

Control Relays

DILER-... + RCDILE; DILER-... + VGDILE

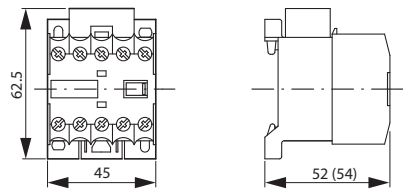

Control Relays

DILER-... + ... (D)DILE

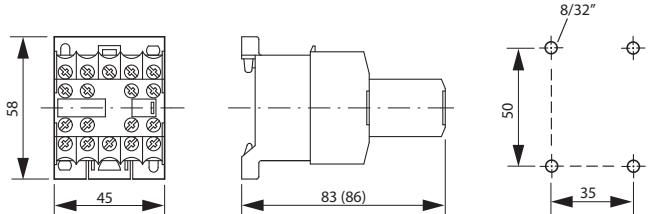

Varistor / RC Suppressors

DILM12-XSP...

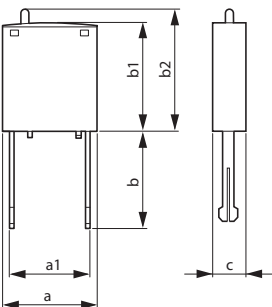

dimension	DILM12-XSPR... DILM12-XSPV...
a	25
a1	9.2
b	25.9
b1	28
b2	~ 32
c	9

Timing Modules

DILM32-XTE...

